

SCO O-Ring Face Seal Fittings

The best partner for value creation
We support the innovations of customer



05



Catalogue No. S-LOK Jan.2023

Union Gland



186

S-LOK Tube Connector Gland



186

Tube Adapter Gland



187

Tube Socket Weld Gland



187

Tube Socket Weld Reducing Gland



187

Male Tube Weld Gland



188

Automatic Tube Weld Gland



188

Male Connector Gland



188

Female Connector Gland



189

Male SAE/MS Connector Gland



189

Union Body



190

Reducing Union Body



190

S-LOK Tube Fitting Connector Body



190

Elbow Body



191

Tee Body



191

Bulkhead Union Body



191

S-LOK Tube Fitting Bulkhead Connector Body



192

S-LOK Tube Fitting Elbow Body



192

Tube Socket Weld Body



193

Automatic Tube Weld Body



193

Male Connector Body



193

Female Connector Body



194

Male SAE/MS Connector Body



194

Male Elbow Body



195

Male SAE/MS Positionable Elbow Body



195

Blind



195

Female Nut



196

Blind Nut



196

Features

- Designed for quick assembly in pipe, tube and welded systems.
- Easy installation and disassembly
- Leak-tight from vacuum to positive pressure
- Wide range of temperature up to 550°F
- Smooth finish on gland face
- Nuts with two test ports
- Silver plated nut thread



Technical Data

Pressure Ratings

- Pressure ratings comply with calculations in accordance with ASME B31.3 and ASME B31.1.

Temperature Ratings

- Temperature ratings are determined by the O-ring materials.
- Fluorocarbon FKM O-ring is standard.
- Other o-ring materials are available upon request.
- Refer to the table below for the temperature range for o-ring materials.

O-Ring Material	Temperature Rating °F (°C)
Fluorocarbon FKM	400 (204)
Buna N	250 (121)
Perfluoroelastomer	550 (287)
Ethylene propylene	300 (148)
PTFE	450 (232)

Typical Assembly

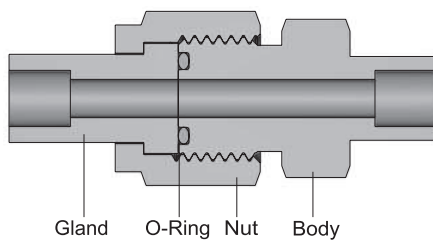

Standard Materials of Construction

Component	Material
Bodies	316 Stainless Steel
Glands	316 Stainless Steel
Nuts	316 Stainless Steel
Automatic tube weld fittings	316L Stainless Steel
O-ring for SCO bodies	Fluorocarbon FKM (75 durometer)
O-ring for SAE/MS threads	Fluorocarbon FKM (90 durometer)

O-Ring Uniform Size Number

Fluorocarbon FKM O-ring (Hardness Shore A 75) is standard on SCO bodies.

SCO Size inch	O-Ring Uniform Size Number
1/4 (& 1/8)	010
1/2 (& 3/8)	111
3/4	116
1	215

Fluorocarbon FKM O-ring (Hardness Shore A 90) is standard on SAE/MS threads.

SAE/MS Thread Size	O-Ring Uniform Size Number
7/16 – 20	904
9/16 – 18	906
3/4 – 16	908
1-1/16 – 12	912
1-5/16 – 12	916

Helium Leak Testing

- Maximum leak rate : 4×10^{-9} std cm³/s

Ordering Information and Dimension



- **O-Ring Material**
 - Nil : Fluorocarbon FKM
 - **NBR** : Buna N
 - **KA** : Perfluoroelastomer
 - **EP** : Ethylene propylene
 - **TE** : PTFE
- **Body Material**
 - **S6** : SS316
 - **S6L** : SS316L

Union Gland

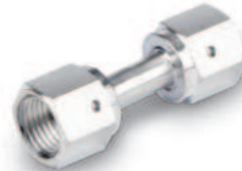
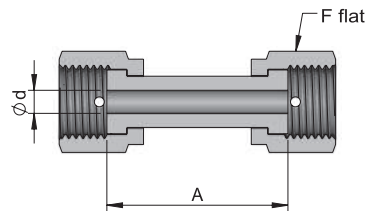

Part Number	SCO Size	Dimensions, inch (mm)			Pressure Rating psig (bar)
		d	A	F	
SCO-GU-4	1/4"	0.18(4.6)	1.42(36.1)	11/16(17.46)	10200(702)
SCO-GU-8	1/2"	0.40(10.2)	1.61(40.9)	1(25.4)	5800(399)

S-LOK Tube Connector Gland

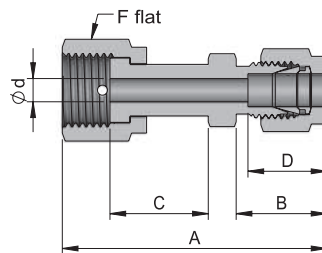

Part Number	SCO Size	Tube O.D.	Dimensions, inch (mm)						Pressure Rating psig (bar)
			d	A	B	C	D	F	
SCO-GSC-4-4T	1/4"	1/4"	0.18(4.6)	1.74(44.2)	0.70(17.8)	0.77(19.6)	0.60(15.2)	11/16(17.46)	10200(702)
SCO-GSC-8-6T	1/2"	3/8"	0.28(7.1)	1.87(47.5)	0.76(19.3)	0.81(20.6)	0.66(16.8)	1(25.40)	5800(399)
SCO-GSC-8-8T	1/2"	1/2"	0.40(10.2)	2.01(51.1)	0.87(22.1)	0.81(20.6)	0.90(22.9)	1(25.40)	5800(399)
SCO-GSC-12-12T	3/4"	3/4"	0.62(15.7)	2.14(54.4)	0.87(22.1)	0.94(23.9)	0.96(24.4)	1-1/2(38.10)	4000(275)
SCO-GSC-16-16T	1"	1"	0.87(22.1)	2.45(62.2)	1.04(26.4)	0.98(24.9)	1.23(31.2)	1-3/4(44.45)	3000(206)

Tube Adapter Gland

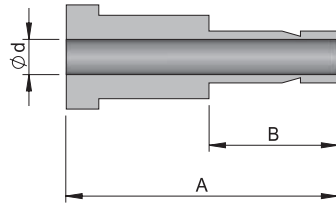

Part Number	SCO Size	Tube O.D	Dimensions, inch (mm)			Pressure Rating psig (bar)
			d	A	B	
SCO-GA-4-4T	1/4"	1/4"	0.18(4.6)	1.31(33.3)	0.64(16.3)	10200(702)
SCO-GA-8-6T	1/2"	3/8"	0.27(6.8)	1.38(35.1)	0.70(17.8)	6500(447)
SCO-GA-8-8T	1/2"	1/2"	0.37(9.3)	1.62(41.1)	0.96(24.4)	6700(461)
SCO-GA-12-12T	3/4"	3/4"	0.58(14.7)	1.80(45.7)	1.02(25.9)	5800(399)
SCO-GA-16-16T	1"	1"	0.80(20.3)	2.05(52.1)	1.30(33.0)	4700(323)

Tube Socket Weld Gland

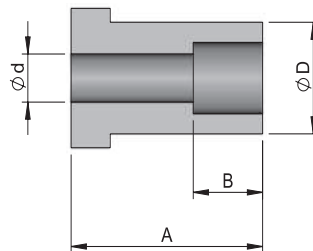

Part Number	SCO Size	Tube O.D	Dimensions, inch (mm)				Pressure Rating psig (bar)
			d	A	B	D	
SCO-GSWC-4-2T	1/4"	1/8"	0.09(2.3)	0.77(19.6)	0.10(2.5)	0.38(9.7)	15400(1061)
SCO-GSWC-4-4T	1/4"	1/4"	0.18(4.6)	0.77(19.6)	0.28(7.1)	0.38(9.7)	6800(468)
SCO-GSWC-6-6T	3/8"	3/8"	0.28(7.1)	0.81(20.6)	0.31(7.9)	0.60(15.2)	8100(558)
SCO-GSWC-8-8T	1/2"	1/2"	0.40(10.2)	0.81(20.6)	0.38(9.7)	0.73(18.5)	3000(206)
SCO-GSWC-12-12T	3/4"	3/4"	0.62(15.7)	0.94(23.9)	0.44(11.2)	0.92(23.4)	3700(255)
SCO-GSWC-16-16T	1"	1"	0.87(22.1)	0.98(24.9)	0.62(15.7)	1.19(30.2)	3000(206)

Tube Socket Weld Reducing Gland

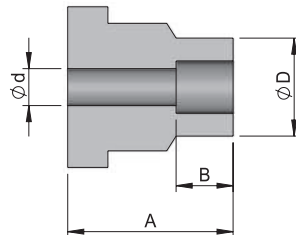

Part Number	SCO Size	Tube O.D	Dimensions, inch (mm)				Pressure Rating psig (bar)
			d	A	B	D	
SCO-GSWR-4-2T	1/4"	1/8"	0.09(2.3)	0.77(19.6)	0.10(2.5)	0.29(7.4)	12600(868)
SCO-GSWR-8-4T	1/2"	1/4"	0.18(4.6)	0.81(20.6)	0.28(7.1)	0.48(12.2)	10700(737)

Male Tube Weld Gland

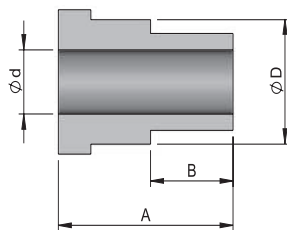

Part Number	SCO Size	Tube O.D	Dimensions, inch (mm)				Pressure Rating psig (bar)
			d	A	B	D	
SCO-GWC-4-2T	1/4"	1/8"	0.06(1.5)	0.77(19.6)	0.28(7.1)	0.38(9.7)	11200(771)
SCO-GWC-4-4T	1/4"	1/4"	0.12(3.0)	1.12(28.4)	0.41(10.4)	0.38(9.7)	11200(771)
SCO-GWC-8-4T	1/2"	1/4"	0.12(3.0)	0.91(23.1)	0.41(10.4)	0.60(15.2)	11200(771)
SCO-GWC-8-6T	1/2"	3/8"	0.23(5.8)	0.84(21.3)	0.41(10.4)	0.60(15.2)	8200(564)
SCO-GWC-8-8T	1/2"	1/2"	0.33(8.4)	1.06(26.9)	0.50(12.7)	0.60(15.2)	7500(516)

Automatic Tube Weld Gland

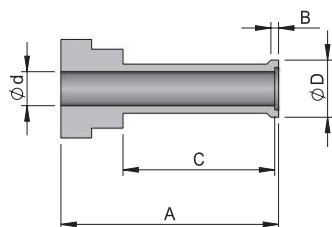

Part Number	SCO Size	Tube O.D	Dimensions, inch (mm)					Pressure Rating psig (bar)
			d	A	B	C	D	
SCO-GWAC-4-4T	1/4"	1/4"	0.18(4.6)	1.12(28.4)	0.02(0.51)	0.78(19.8)	0.29(7.4)	5100(351)
SCO-GWAC-8-6T	1/2"	3/8"	0.31(7.9)	1.13(28.7)	0.03(0.76)	0.79(20.0)	0.41(10.4)	3300(227)
SCO-GWAC-8-8T	1/2"	1/2"	0.40(10.2)	1.14(29.0)	0.04(1.0)	0.80(20.3)	0.55(14.0)	3500(241)
SCO-GWAC-12-12T	3/4"	3/4"	0.65(16.5)	1.20(30.5)	0.04(1.0)	0.80(20.3)	0.80(20.3)	2200(151)
SCO-GWAC-16-16T	1"	1"	0.87(22.1)	1.41(35.8)	0.04(1.0)	1.00(25.4)	1.06(26.9)	2200(151)

Male Connector Gland

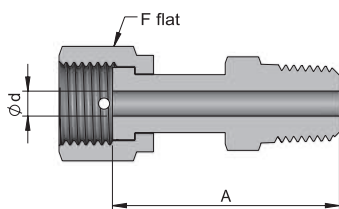

Part Number	SCO Size	NPT Size	Dimensions, inch (mm)			Pressure Rating psig (bar)
			d	A	F	
SCO-GMC-4-4N	1/4"	1/4"	0.18(4.6)	1.59(40.4)	11/16(17.46)	9800(675)
SCO-GMC-8-6N	1/2"	3/8"	0.40(10.2)	1.67(42.4)	1(25.4)	5600(385)
SCO-GMC-8-8N	1/2"	1/2"	0.40(10.2)	1.87(47.5)	1(25.4)	5600(385)
SCO-GMC-12-12N	3/4"	3/4"	0.62(15.7)	2.03(51.6)	1-1/2(38.10)	3900(268)
SCO-GMC-16-16N	1"	1"	0.87(22.1)	2.36(59.9)	1-3/4(44.45)	2900(199)

Female Connector Gland

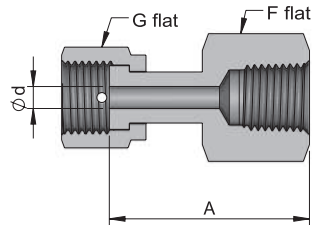

Part Number	SCO Size	NPT Size	Dimensions, inch (mm)				Pressure Rating psig (bar)
			d	A	F	G	
SCO-GFC-4-4N	1/4"	1/4"	0.18(4.6)	1.57(39.9)	3/4(19.05)	11/16(17.46)	6600(454)
SCO-GFC-8-6N	1/2"	3/8"	0.40(10.2)	1.73(43.9)	7/8(22.22)	1(25.4)	5300(365)
SCO-GFC-8-8N	1/2"	1/2"	0.40(10.2)	1.96(49.8)	1-1/16(26.98)	1(25.4)	4900(337)
SCO-GFC-12-12N	3/4"	3/4"	0.62(15.7)	2.12(53.8)	1-5/16(33.33)	1-1/2(38.10)	4000(275)
SCO-GFC-16-16N	1"	1"	0.87(22.1)	2.29(58.2)	1-5/8(41.27)	1-3/4(44.45)	3000(206)

Male SAE/MS Connector Gland

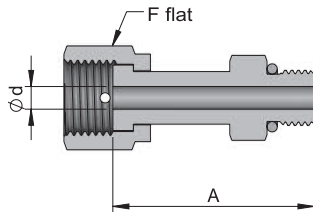

Part Number	SCO Size	Straight Thread Size	Dimensions, inch (mm)			Pressure Rating psig (bar)
			d	A	F	
SCO-GUS-4-4U	1/4"	7/16 – 20	0.18(4.6)	1.54(39.1)	11/16(17.46)	4500(310)
SCO-GUS-8-6U	1/2"	9/16 – 18	0.40(10.2)	1.64(41.7)	1(25.4)	4500(310)
SCO-GUS-8-8U	1/2"	3/4 – 16	0.40(10.2)	1.71(43.4)	1(25.4)	4500(310)
SCO-GUS-12-12U	3/4"	1-1/16 – 12	0.62(15.7)	2.07(52.6)	1-1/2(38.10)	3600(248)
SCO-GUS-16-16U	1"	1-5/16 – 12	0.87(22.1)	2.17(55.1)	1-3/4(44.45)	2900(199)

Union Body

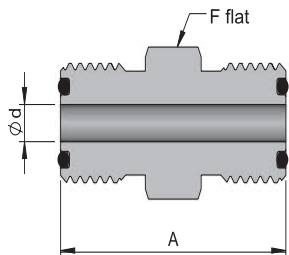

Part Number	SCO Size	Dimensions, inch (mm)			Pressure Rating psig (bar)
		d	A	F	
SCO-BU-4	1/4"	0.18(4.6)	1.25(31.8)	5/8(15.87)	14300(985)
SCO-BU-8	1/2"	0.40(10.2)	1.50(38.1)	15/16(23.81)	11100(764)

Reducing Union Body

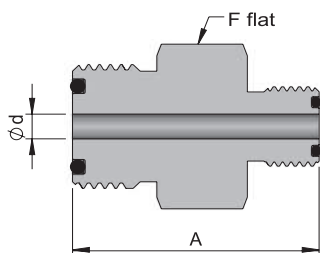

Part Number	SCO Size 1	SCO Size 2	Dimensions, inch (mm)			Pressure Rating psig (bar)
			d	A	F	
SCO-BUR-8-4	1/2"	1/4"	0.18(4.6)	1.43(36.3)	15/16(23.81)	11100(764)

S-LOK Tube Fitting Connector Body

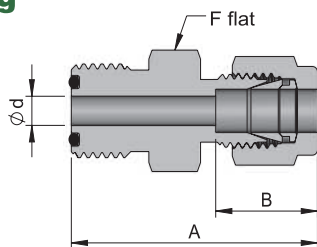

Part Number	SCO Size	Tube O.D.	Dimensions, inch (mm)				Pressure Rating psig (bar)
			d	A	B	F	
SCO-BSC-4-2T	1/4"	1/8"	0.09(2.3)	1.38(35.1)	0.51(13.0)	5/8(15.87)	10900(751)
SCO-BSC-4-4T	1/4"	1/4"	0.18(4.6)	1.47(37.3)	0.60(15.2)	5/8(15.87)	10200(702)
SCO-BSC-8-6T	1/2"	3/8"	0.28(7.1)	1.65(41.9)	0.66(16.8)	15/16(23.81)	6500(447)
SCO-BSC-8-8T	1/2"	1/2"	0.40(10.2)	1.78(45.2)	0.90(22.9)	15/16(23.81)	6700(461)
SCO-BSC-12-12T	3/4"	3/4"	0.62(15.7)	1.86(47.2)	0.96(24.4)	1-5/16(33.33)	5800(399)
SCO-BSC-16-16T	1"	1"	0.87(22.1)	2.06(52.3)	1.23(31.2)	1-5/8(41.27)	4700(323)

Elbow Body

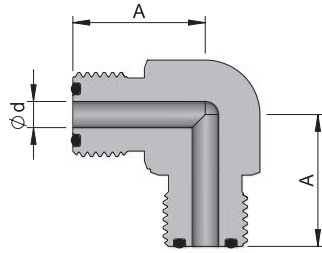

Part Number	SCO Size	Dimensions, inch (mm)		Pressure Rating psig (bar)
		d	A	
SCO-BL-4	1/4"	0.18(4.6)	0.96(24.4)	14300(985)
SCO-BL-8	1/2"	0.40(10.2)	1.26(32.0)	11100(764)
SCO-BL-12	3/4"	0.62(15.7)	1.48(37.6)	10900(751)
SCO-BL-16	1"	0.87(22.1)	1.56(39.6)	8800(606)

Tee Body

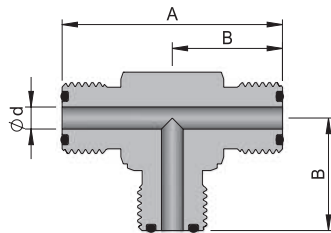

Part Number	SCO Size	Dimensions, inch (mm)			Pressure Rating psig (bar)
		d	A	B	
SCO-BT-4	1/4"	0.18(4.6)	1.92(48.8)	0.96(24.4)	14300(985)
SCO-BT-8	1/2"	0.40(10.2)	2.52(64.0)	1.26(32.0)	11100(764)
SCO-BT-12	3/4"	0.62(15.7)	2.96(75.2)	1.48(37.6)	10900(751)
SCO-BT-16	1"	0.87(22.1)	3.12(79.2)	1.56(39.6)	8800(606)

Bulkhead Union Body

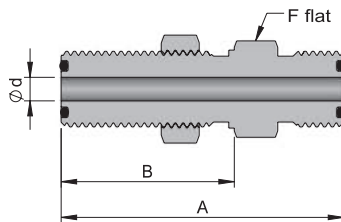

Part Number	SCO Size	Dimensions, inch (mm)						Pressure Rating psig (bar)
		d	A	B	F	Panel Hole Drill Size	Max. Panel Thickness	
SCO-BBU-4	1/4"	0.18(4.6)	1.88(47.8)	1.06(26.9)	3/4(19.05)	37/64(14.68)	0.36(9.1)	14300(985)
SCO-BBU-8	1/2"	0.40(10.2)	2.09(53.1)	1.19(30.2)	1-1/16(26.98)	57/64(22.62)	0.40(10.2)	11100(764)

S-LOK Tube Fitting Bulkhead Connector Body

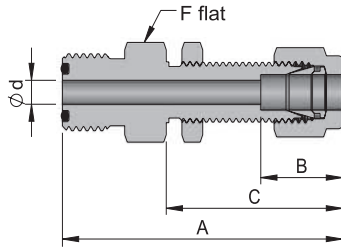

Part Number	SCO Size	Tube O.D.	Dimensions, inch (mm)							Pressure Rating psig (bar)
			d	A	B	C	F	Panel Hole Drill Size	Max. Panel THK.	
SCO-BSCB-4-4T	1/4"	1/4"	0.18(4.6)	2.10(53.3)	0.60(15.2)	1.32(33.5)	5/8(15.87)	29/64(11.50)	0.40(10.2)	10200(702)
SCO-BSCB-8-6T	1/2"	3/8"	0.28(7.1)	2.34(59.4)	0.66(16.8)	1.45(36.8)	15/16(23.81)	37/64(14.68)	0.44(11.2)	6500(447)
SCO-BSCB-8-8T	1/2"	1/2"	0.40(10.2)	2.55(64.8)	0.90(22.9)	1.65(41.9)	15/16(23.81)	49/64(19.44)	0.50(12.7)	6700(461)
SCO-BSCB-12-12T	3/4"	3/4"	0.62(15.7)	2.86(72.6)	0.96(24.4)	1.87(47.5)	1-5/16(33.33)	1-1/64(25.79)	0.66(16.8)	5800(399)
SCO-BSCB-16-16T	1"	1"	0.87(22.1)	3.29(83.6)	1.23(31.2)	2.26(57.4)	1-5/8(41.27)	1-21/64(33.73)	0.75(19.0)	4700(323)

S-LOK Tube Fitting Elbow Body

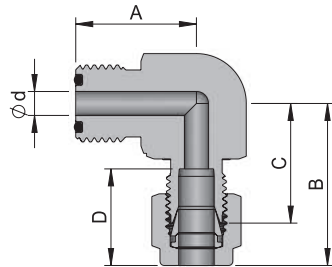

Part Number	SCO Size	Tube O.D.	Dimensions, inch (mm)					Pressure Rating psig (bar)
			d	A	B	C	D	
SCO-BSL-4-4T	1/4"	1/4"	0.18(4.6)	0.96(24.4)	1.19(30.2)	0.90(22.9)	0.60(15.2)	10200(702)
SCO-BSL-8-6T	1/2"	3/8"	0.28(7.1)	1.26(32.0)	1.39(35.3)	1.10(27.9)	0.66(16.8)	6500(447)
SCO-BSL-8-8T	1/2"	1/2"	0.40(10.2)	1.26(32.0)	1.50(38.1)	1.10(27.9)	0.90(22.9)	6700(461)
SCO-BSL-12-12T	3/4"	3/4"	0.62(15.7)	1.48(37.6)	1.80(45.7)	1.40(35.6)	0.96(24.4)	5800(399)
SCO-BSL-16-16T	1"	1"	0.87(22.1)	1.56(39.6)	2.04(51.8)	1.56(39.6)	1.23(31.2)	4700(323)

Tube Socket Weld Body

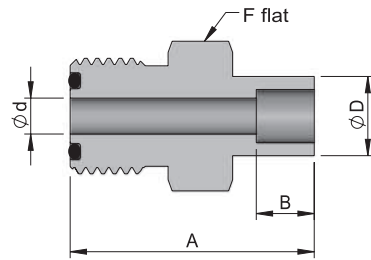

Part Number	SCO Size	Tube O.D	Dimensions, inch (mm)					Pressure Rating psig (bar)
			d	A	B	D	F	
SCO-BSWC-4-2T	1/4"	1/8"	0.09(2.3)	0.88(22.4)	0.10(2.5)	0.29(7.4)	5/8(15.87)	12600(868)
SCO-BSWC-4-4T	1/4"	1/4"	0.18(4.6)	1.09(27.7)	0.28(7.1)	0.38(9.7)	5/8(15.87)	6800(468)
SCO-BSWC-8-6T	1/2"	3/8"	0.28(7.1)	1.28(32.5)	0.31(7.9)	0.60(15.2)	15/16(23.81)	8100(558)
SCO-BSWC-8-8T	1/2"	1/2"	0.40(10.2)	1.34(34.0)	0.38(9.7)	0.73(18.5)	15/16(23.81)	3000(206)
SCO-BSWC-12-12T	3/4"	3/4"	0.62(15.7)	1.50(38.1)	0.44(11.2)	0.92(23.4)	1-5/16(33.33)	3700(254)
SCO-BSWC-16-16T	1"	1"	0.87(22.1)	1.72(43.7)	0.62(15.7)	1.19(30.2)	1-5/8(41.27)	3000(206)

Automatic Tube Weld Body

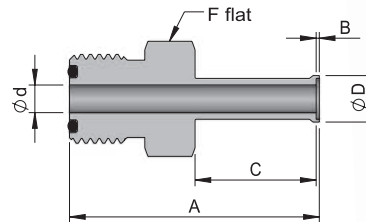

Part Number	SCO Size	Tube O.D	Dimensions, inch (mm)						Pressure Rating psig (bar)
			d	A	B	C	D	F	
SCO-BWAC-4-4T	1/4"	1/4"	0.18(4.6)	1.59(40.4)	0.02(0.51)	0.78(19.8)	0.29(7.4)	5/8(15.87)	5100(351)
SCO-BWAC-8-6T	1/2"	3/8"	0.31(7.9)	1.74(44.2)	0.03(0.76)	0.79(20.0)	0.41(10.4)	15/16(23.81)	3300(227)
SCO-BWAC-8-8T	1/2"	1/2"	0.40(10.2)	1.75(44.4)	0.04(1.0)	0.80(20.3)	0.55(14.0)	15/16(23.81)	3500(241)
SCO-BWAC-12-12T	3/4"	3/4"	0.65(16.5)	1.78(45.2)	0.04(1.0)	0.80(20.3)	0.80(20.3)	1-5/16(33.33)	2200(151)
SCO-BWAC-16-16T	1"	1"	0.87(22.1)	20.3(51.6)	0.04(1.0)	1.00(25.4)	1.06(26.9)	1-5/8(41.27)	2200(151)

Male Connector Body

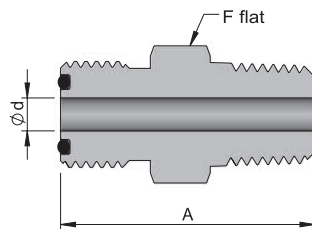

Part Number	SCO Size	NPT Size	Dimensions, inch (mm)			Pressure Rating psig (bar)
			d	A	F	
SCO-BMC-4-2N	1/4"	1/8"	0.18(4.6)	1.16(29.5)	5/8(15.87)	10000(689)
SCO-BMC-4-4N	1/4"	1/4"	0.18(4.6)	1.34(34.0)	5/8(15.87)	13400(923)
SCO-BMC-8-6N	1/2"	3/8"	0.38(9.7)	1.46(37.1)	15/16(23.81)	7800(537)
SCO-BMC-8-8N	1/2"	1/2"	0.40(10.2)	1.65(41.9)	15/16(23.81)	10000(689)
SCO-BMC-12-12N	3/4"	3/4"	0.62(15.7)	1.75(44.4)	1-5/16(33.33)	7300(502)
SCO-BMC-16-16N	1"	1"	0.87(22.1)	1.97(50.0)	1-5/8(41.27)	5300(365)

Female Connector Body

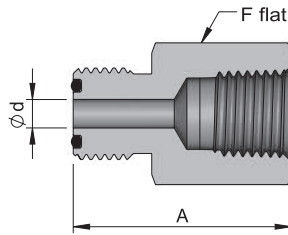

Part Number	SCO Size	NPT Size	Dimensions, inch (mm)			Pressure Rating psig (bar)
			d	A	F	
SCO-BFC-4-2N	1/4"	1/8"	0.18(4.6)	1.25(31.8)	5/8(15.87)	8400(578)
SCO-BFC-4-4N	1/4"	1/4"	0.18(4.6)	1.39(35.3)	3/4(19.05)	6600(454)
SCO-BFC-8-6N	1/2"	3/8"	0.40(10.2)	1.57(39.9)	15/16(23.81)	6600(454)
SCO-BFC-8-8N	1/2"	1/2"	0.40(10.2)	1.77(45.0)	1-1/16(26.98)	4900(337)
SCO-BFC-12-12N	3/4"	3/4"	0.62(15.7)	1.93(49.0)	1-5/16(33.33)	4600(316)
SCO-BFC-16-16N	1"	1"	0.87(22.1)	2.02(51.3)	1-5/8(41.27)	4400(303)

Male SAE/MS Connector Body

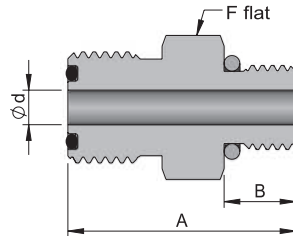

Part Number	SCO Size	Straight Thread Size	Dimensions, inch (mm)				Pressure Rating psig (bar)
			d	A	B	F	
SCO-BUS-4-4U	1/4"	7/16 – 20	0.18(4.6)	1.24(31.5)	0.36(9.1)	11/16(17.46)	4500(310)
SCO-BUS-4-6U	1/4"	9/16 – 18	0.18(4.6)	1.17(29.7)	0.39(9.9)	11/16(17.46)	4500(310)
SCO-BUS-8-4U	1/2"	7/16 – 20	0.18(4.6)	1.36(34.5)	0.36(9.1)	15/16(23.81)	4500(310)
SCO-BUS-8-6U	1/2"	9/16 – 18	0.30(7.6)	1.39(35.3)	0.39(9.9)	15/16(23.81)	4500(310)
SCO-BUS-8-8U	1/2"	3/4 – 16	0.40(10.2)	1.47(37.3)	0.44(11.2)	1(25.40)	4500(310)
SCO-BUS-12-12U	3/4"	1-1/16 – 12	0.62(15.7)	1.73(43.9)	0.59(15.0)	1-3/8(34.92)	3600(248)
SCO-BUS-16-16U	1"	1-5/16 – 12	0.85(21.6)	1.79(45.5)	0.59(15.0)	1-5/8(41.27)	2900(199)

Male Elbow Body

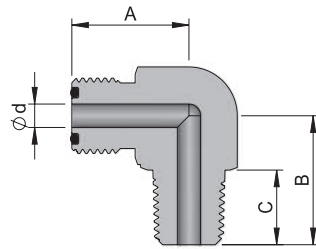

Part Number	SCO Size	NPT Size	Dimensions, inch (mm)				Pressure Rating psig (bar)
			d	A	B	C	
SCO-BLM-4-2N	1/4"	1/8"	0.18(4.6)	0.96(24.4)	0.87(22.1)	0.38(9.7)	10000(689)
SCO-BLM-4-4N	1/4"	1/4"	0.18(4.6)	0.96(24.4)	1.05(26.7)	0.56(14.2)	8000(551)
SCO-BLM-8-6N	1/2"	3/8"	0.38(9.7)	1.26(32.0)	1.26(32.0)	0.56(14.2)	7800(537)
SCO-BLM-8-8N	1/2"	1/2"	0.40(10.2)	1.26(32.0)	1.45(36.8)	0.75(19.0)	7700(530)
SCO-BLM-12-12N	3/4"	3/4"	0.62(15.7)	1.48(37.6)	1.67(42.4)	0.75(19.0)	7300(502)
SCO-BLM-16-16N	1"	1"	0.87(22.1)	1.56(39.6)	1.94(49.3)	0.94(23.9)	5300(365)

Male SAE/MS Positionable Elbow Body

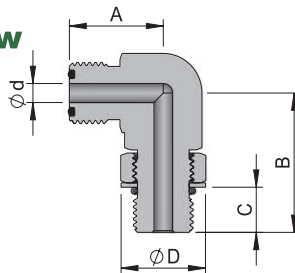

Part Number	SCO Size	Straight Thread Size	Dimensions, inch (mm)					Pressure Rating psig (bar)
			d	A	B	C	D	
SCO-BLS-4-4U	1/4"	7/16 – 20	0.18(4.6)	0.96(24.4)	1.19(30.2)	0.39(9.9)	0.65(16.5)	4500(310)
SCO-BLS-8-6U	1/2"	9/16 – 18	0.30(7.6)	1.33(33.8)	1.54(39.1)	0.44(11.2)	0.79(20.1)	3600(248)
SCO-BLS-8-8U	1/2"	3/4 – 16	0.40(10.2)	1.33(33.8)	1.65(41.9)	0.50(12.7)	1.01(25.7)	3600(248)
SCO-BLS-12-12U	3/4"	1-1/16 – 12	0.62(15.7)	1.53(38.9)	2.13(54.1)	0.66(16.8)	1.44(36.6)	2900(199)
SCO-BLS-16-16U	1"	1-5/16 – 12	0.87(22.1)	1.72(43.7)	2.31(58.7)	0.66(16.8)	1.73(43.9)	2300(158)

Blind

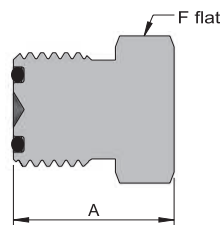

Part Number	SCO Size	Dimensions, inch (mm)	
		A	F
SCO-CAP-4	1/4"	0.77(19.6)	5/8(15.87)
SCO-CAP-8	1/2"	0.89(22.6)	15/16(23.81)
SCO-CAP-12	3/4"	0.99(25.1)	1-5/16(33.33)
SCO-CAP-16	1"	1.02(25.9)	1-5/8(41.27)

Female Nut

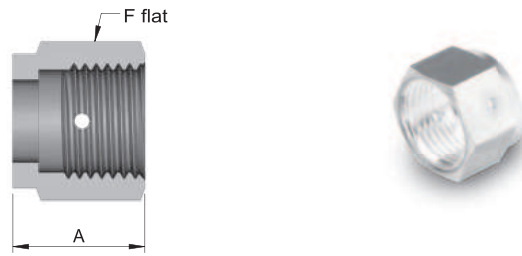

Part Number	SCO Size	Dimensions, inch (mm)	
		A	F
SCO-NUT-4	1/4"	0.66(16.8)	11/16(17.46)
SCO-NUT-8	1/2"	0.69(17.5)	1(25.40)
SCO-NUT-12	3/4"	0.81(20.6)	1-1/2(38.10)
SCO-NUT-16	1"	0.81(20.6)	1-3/4(44.45)

Blind Nut

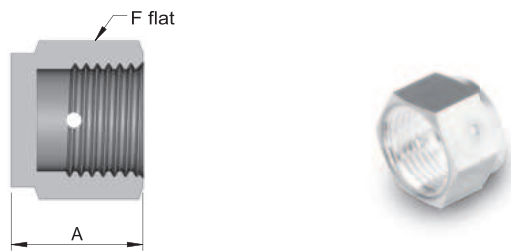

Part Number	SCO Size	Dimensions, inch (mm)	
		A	F
SCO-BLNUT-4	1/4"	0.44(11.2)	11/16(17.46)
SCO-BLNUT-8	1/2"	0.56(14.2)	1(25.40)
SCO-BLNUT-12	3/4"	0.75(19.0)	1-1/2(38.10)
SCO-BLNUT-16	1"	0.81(20.6)	1-3/4(44.45)

SCO Fitting Installation Instruction

1. Rotate the nut finger-tight.

2. Tighten the nut 1/8 turn with spanner.

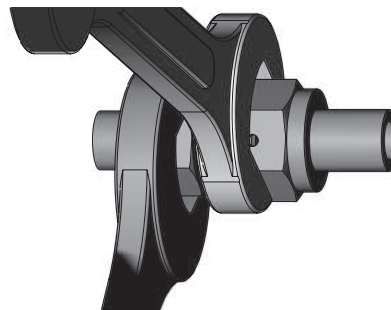
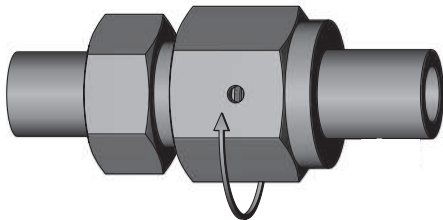

NOTE

O-ring should be removed to prevent thermal damage when welding of bodies or glands.